

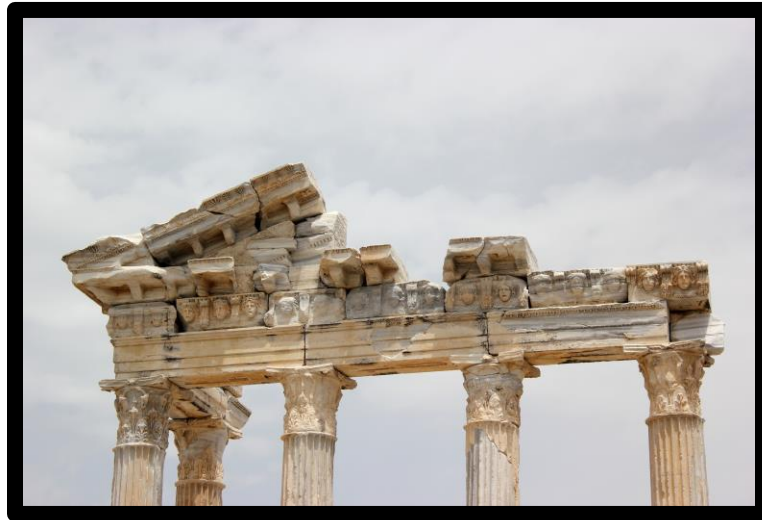

World History

# Ancient Greece Architecture Printable Worksheet Booklet



Name \_\_\_\_\_

**Directions:** Have students circle, point or gaze at each picture as you call each out.

- Ideas:**
1. Use the pictures of each from the book.
  2. Cut out the pictures and attach them onto two Big Mack devices or other talking switches.

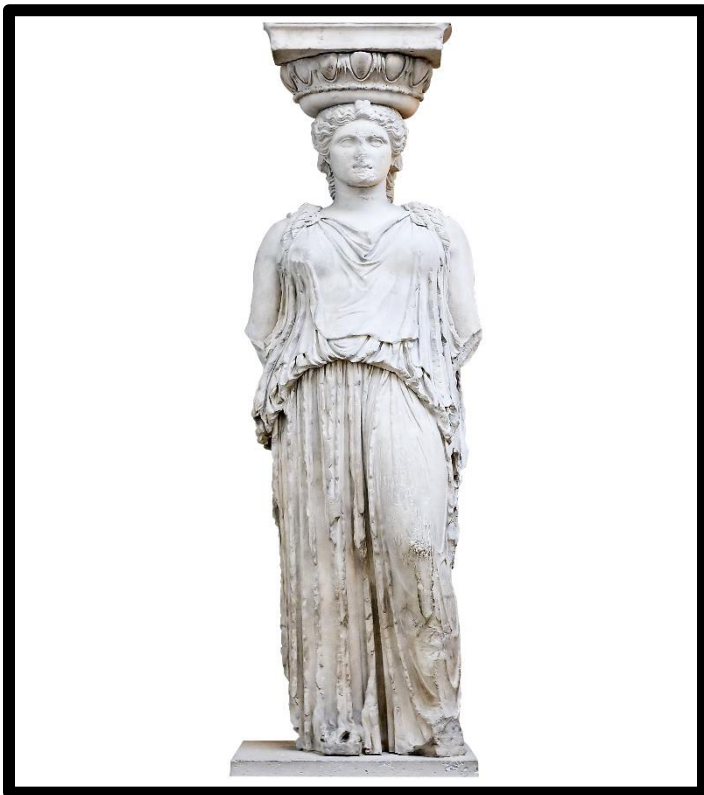

Name \_\_\_\_\_

Directions: Circle the correct answer.

1. What did ancient Greeks use in their architecture?

a

children



b

columns



c

domes

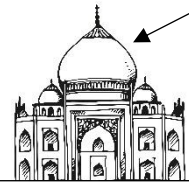

2. What column has a fancy design?

a

Ionic



b

Doric

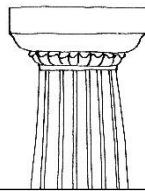

c

Corinthian



3. What column has a plain design?

a

Ionic



b

Doric

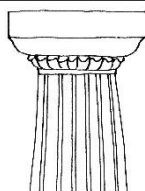

c

Corinthian

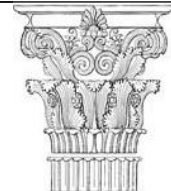

4. What column has a scroll design?

a

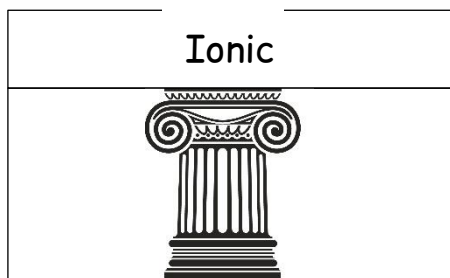

Doric

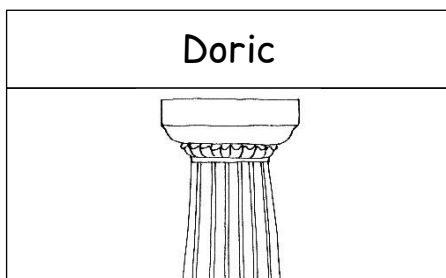

c

Corinthian

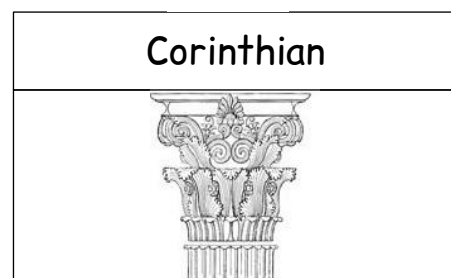

5. What is a scroll?

a

feather

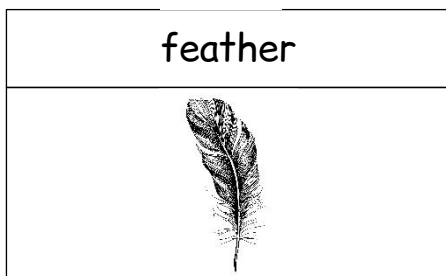

b

ancient book

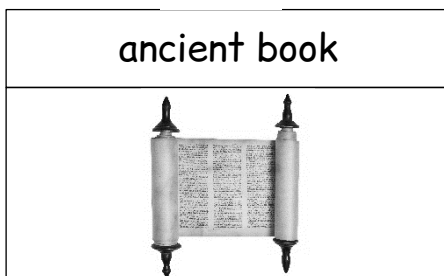

c

vase

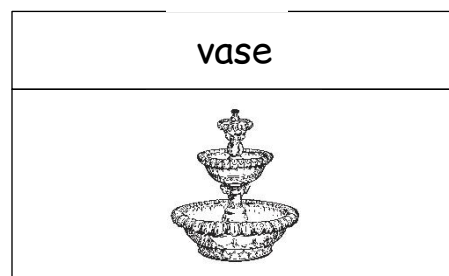

Name \_\_\_\_\_

Directions: Use the word bank to answer the questions.

Corinthian	ancient book	Doric
columns	Ionic	

1. What does ancient Greek architecture have? \_\_\_\_\_

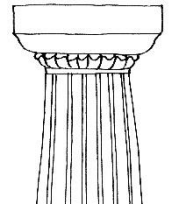

2. What column has a plain design? \_\_\_\_\_



3. What column has a scroll design? \_\_\_\_\_



4. What column has a fancy design? \_\_\_\_\_

5. What is a scroll? \_\_\_\_\_

Name \_\_\_\_\_

**Fact:** Doric columns have a plain design.

**Directions:**

1. Have you ever seen a column like this one? \_\_\_\_\_
2. Color the Doric column.
3. Write "Doric columns are plain" on the line below.
4. Try to draw a Doric column in the box below.

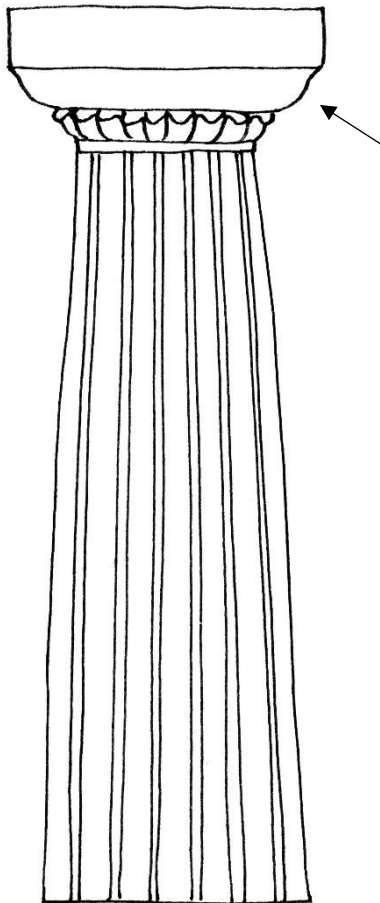

\_\_\_\_\_

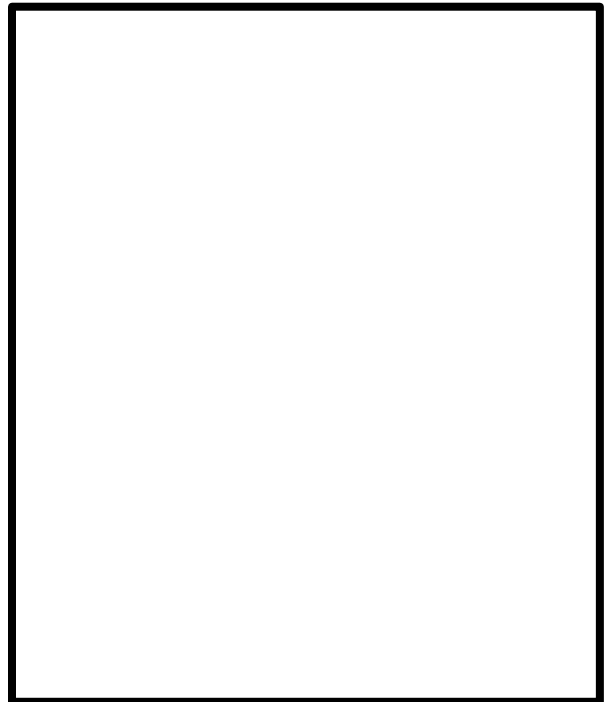

Name \_\_\_\_\_

**Fact:** Ionic columns have a scroll design. A scroll is an ancient book.

**Directions:**

1. Have you ever seen columns like this one? \_\_\_\_\_
2. Color the Ionic column.
3. Write "Ionic columns have scrolls" on the line below.
4. Try to draw an Ionic column in the box below.

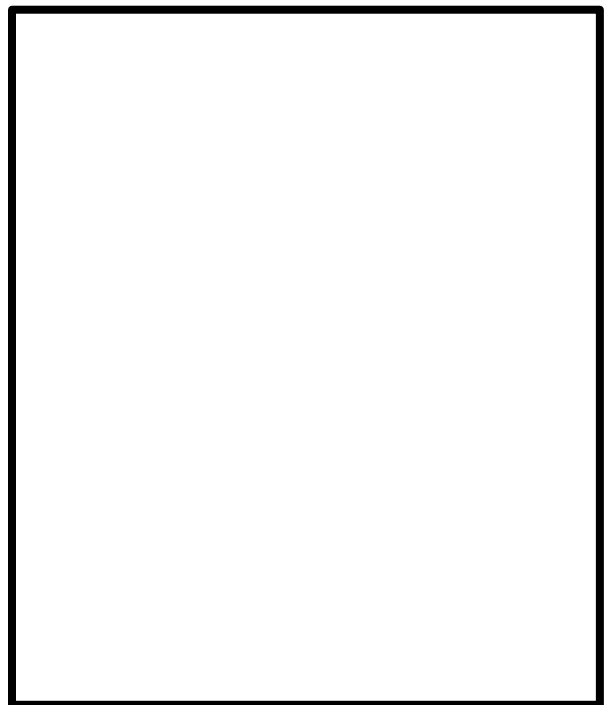
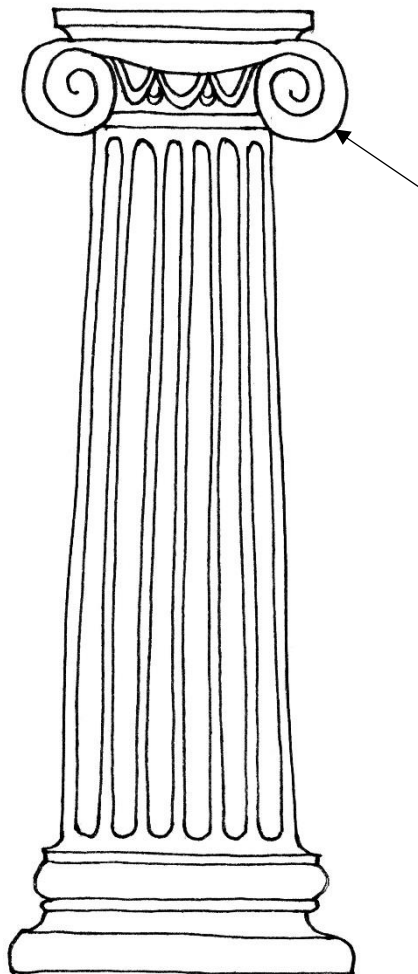

Name \_\_\_\_\_

**Fact:** Corinthian columns have a fancy design.

**Directions:**

1. Have you ever seen a column like this one? \_\_\_\_\_
2. Color the Corinthian column.
3. Write "Corinthian columns are fancy" on the line below.
4. Try to draw a Corinthian column in the box below.

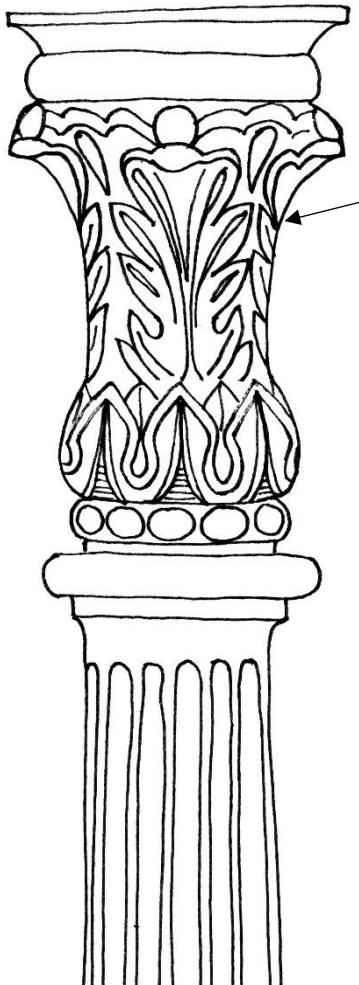

\_\_\_\_\_

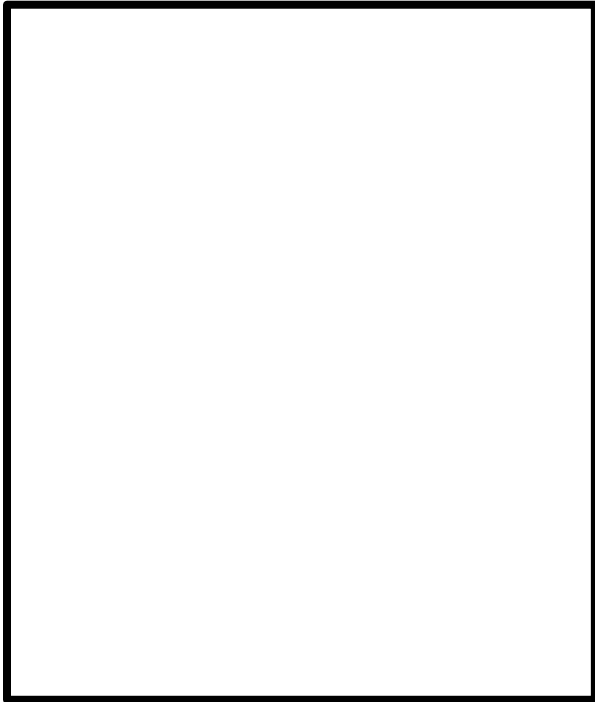



Name \_\_\_\_\_

Directions: Fill in the blank and rewrite the sentence.

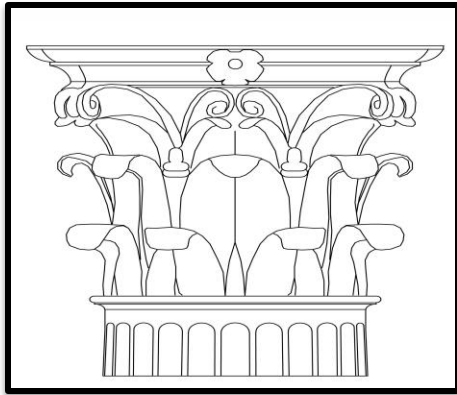

This is a **Corinthian** column.

This is a \_\_\_\_\_ column.

---

---

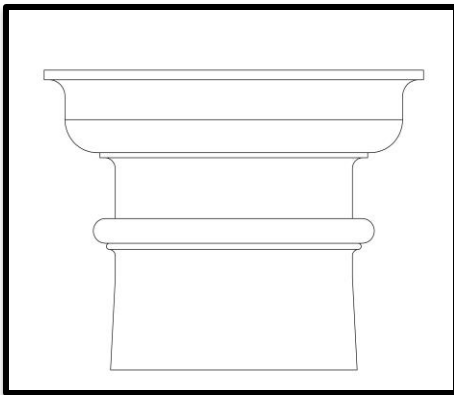

This is a **Doric** column.

This is a \_\_\_\_\_ column.

---

---

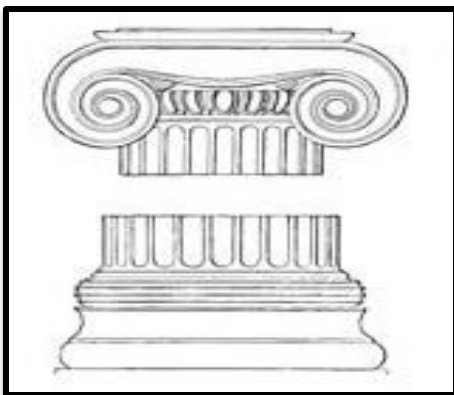

This is an **Ionic** column.

This is an \_\_\_\_\_ column.

---

---

Name \_\_\_\_\_

**Directions:**

1. Circle each picture of the Parthenon.
2. Put an "X" on each picture that is not.

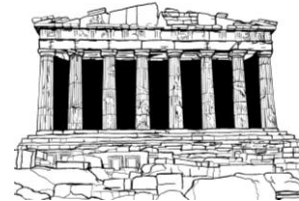

**Supplemental Activity:**

1. Cut out each Parthenon.
2. Glue pictures of each Parthenon on a sheet of paper.

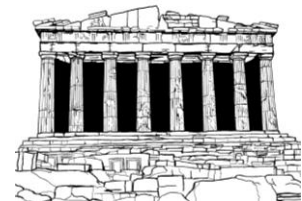
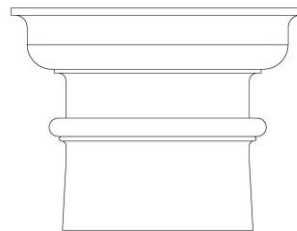
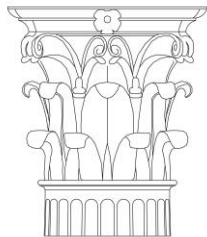
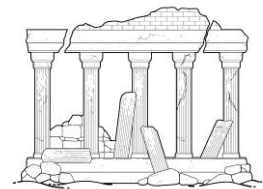

Name \_\_\_\_\_

**Directions:** Complete each sentence with either the word "plain" or "fancy"



1. The vase is \_\_\_\_\_



2. The vase is \_\_\_\_\_



3. The dress is \_\_\_\_\_



4. The column is \_\_\_\_\_

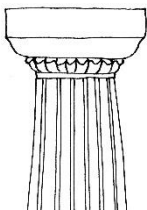

5. The column is \_\_\_\_\_

Name \_\_\_\_\_

**Directions:**

1. Cut out each box below.
2. Paste each box into the correct space.

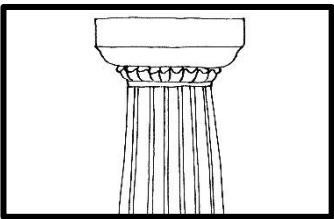

Doric columns are \_\_\_\_\_.

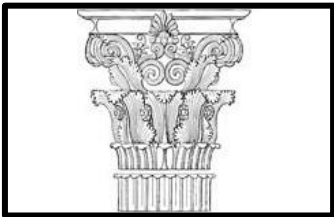

Corinthian columns are \_\_\_\_\_.

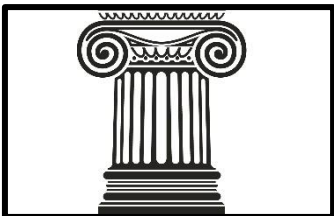

Ionic columns are \_\_\_\_\_.

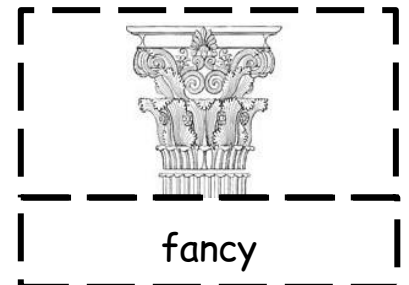
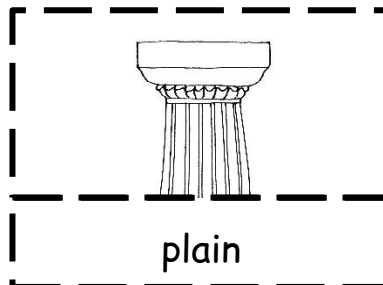
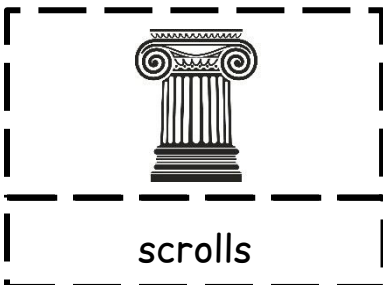

Name \_\_\_\_\_

**Directions:**

1. Cut out each box below.
2. Paste each box into the correct space.

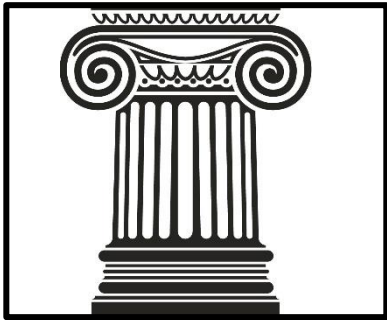

Ionic columns are \_\_\_\_\_.

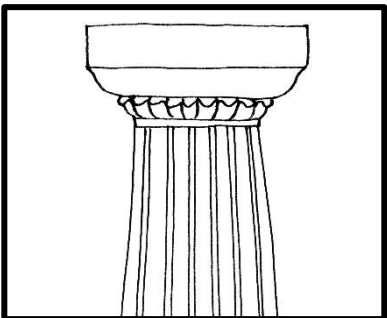

Doric columns are \_\_\_\_\_.



Corinthian columns are \_\_\_\_\_.

plain

fancy

scrolls

Name \_\_\_\_\_

**Directions:**

1. Cut out each box below.
2. Paste each box into the correct space.

1. Many temples have \_\_\_\_\_ in Greece.

2. A Corinthian column has a \_\_\_\_\_ design.

3. A Doric column has a \_\_\_\_\_ design.

4. An Ionic column has a \_\_\_\_\_ design.

fancy

scroll

columns

plain

Name \_\_\_\_\_

**Directions:** Use the sentence template below to write about the **Architecture of Ancient Greece**. You can use the words more than once.

1

2

3

Ancient Greeks  
 A Doric column  
 A Corinthian column  
 An Ionic column

used  
 has

a fancy design  
 a scroll design  
 a plain design  
 columns in architecture

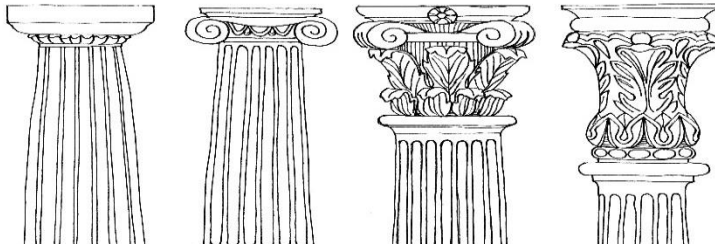

---



---



---



---



---



---

Name \_\_\_\_\_

**Directions:**

1. Go to "search image".
2. Type in each word card.
3. Find a picture that you like. (talk about pictures you find)

**Optional:**

1. Save and upload to a PowerPoint or Word document.
2. Type a word or sentence about each picture.

Ionic column

columns

Doric column

Corinthian column

ancient scroll



Name \_\_\_\_\_

**Directions:** Circle the picture that matches the first picture in the row.

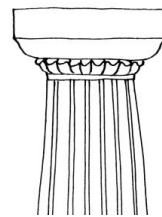
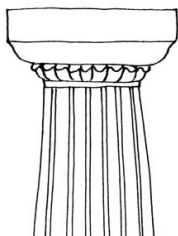
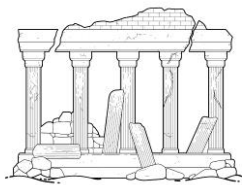
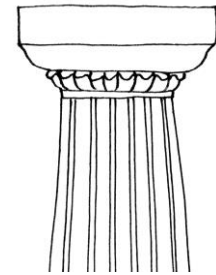

Name \_\_\_\_\_

**Directions:** Draw a line from the definition to the matching word.

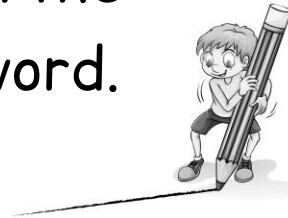

old and broken

scroll

the style of a building

column

ancient book

fall to ruins

tall, thin part of a building

architecture



Name \_\_\_\_\_

Directions: Use the word bank to fill in the blanks.

scroll - ancient book

column - tall, thin part of a building

fall to ruin - old and broken

architecture - the style of a building

1. the style of a building

\_\_\_\_\_

2. ancient book

\_\_\_\_\_

3. old and broken

\_\_\_\_\_

4. tall, thin part of building

\_\_\_\_\_

Name \_\_\_\_\_

Directions: Glue the picture card into the correct box.

What

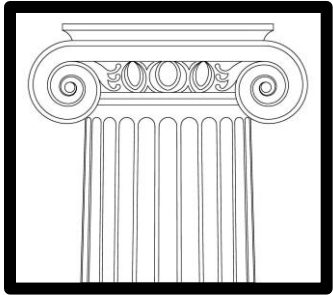

scroll

What

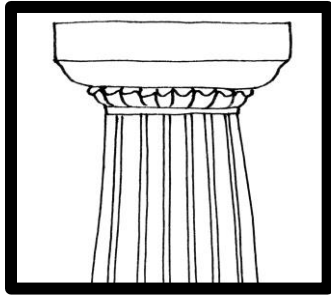

plain

What



women

What

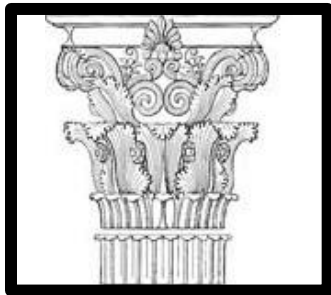

fancy

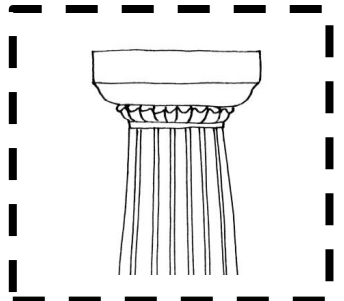
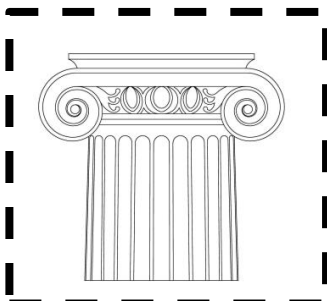

Name \_\_\_\_\_

Directions: Glue the picture card into the correct box.

**Where**

Where are there temples with columns?

Greece

**What**

What design is a Doric column?

scroll

**What**

What design is on a Corinthian column?

fancy

**What**

What design is an Ionic column?

plain

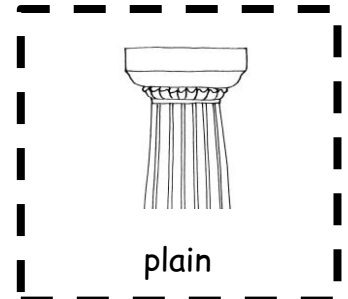
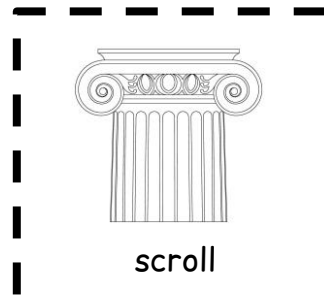
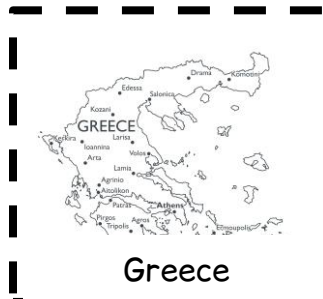
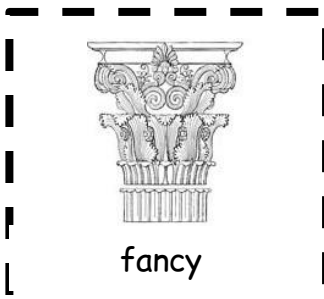

Name \_\_\_\_\_

Directions: Glue the picture card into the correct box.

Where

Where are  
temples with  
columns?

What

What design  
is the  
Corinthian  
column?

What

What design  
is the Doric  
column?

What

What design  
is the Ionic  
column?



Greece



scroll

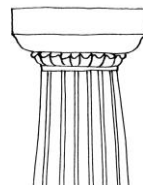

plain



fancy

Name \_\_\_\_\_

**Directions:** Use the words in the text box to answer the questions below.



**When** - time or date



**What** - a thing



**Where** - a place



**Who** - a person or people

simple

fancy

Greece

scroll

**Where** are temples with columns found? \_\_\_\_\_.

**What** design is a Doric column? \_\_\_\_\_.

**What** design is a Ionic column? \_\_\_\_\_.

**What** design is a Corinthian column? \_\_\_\_\_.