



Presents

World War 1

Printable Worksheet Booklet

(Print Landscape)



Name _____



w

a

r

-----Cut letters below and glue above from left to right-----

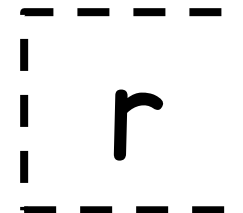
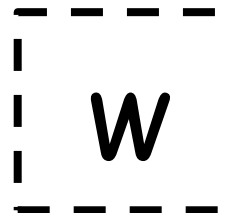
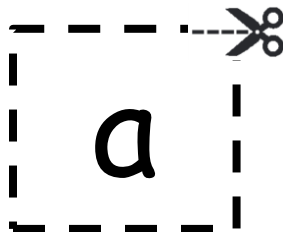

Name _____

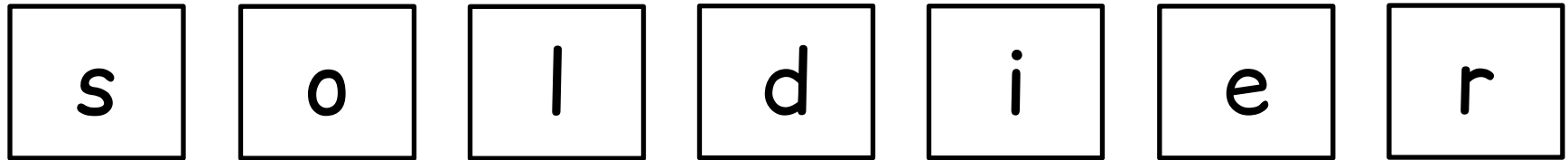

-----Cut letters below and glue above from left to right-----

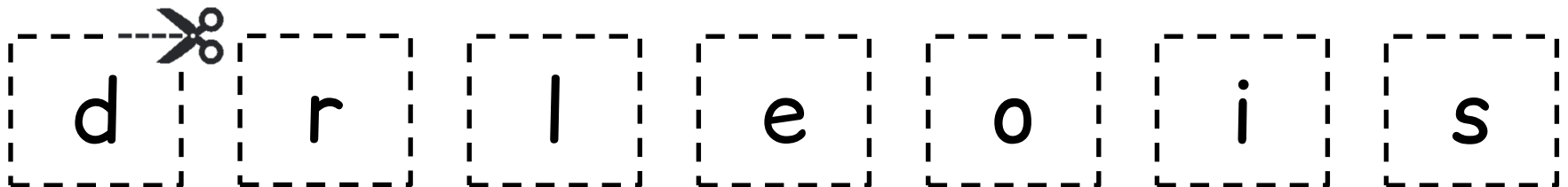

Name _____

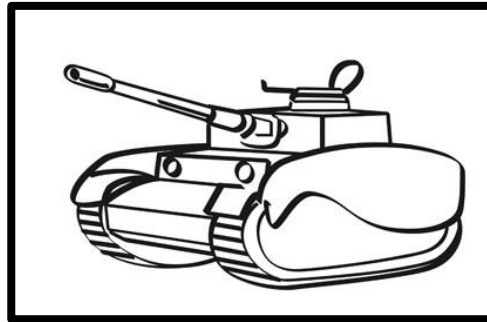

t

a

n

k

-----Cut letters below and glue above from left to right-----

a 

n

t

k

Name _____

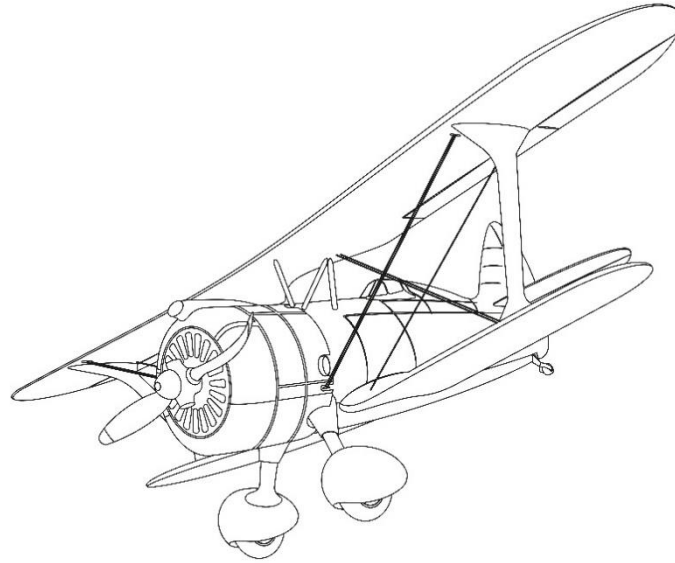

p

l

a

n

e

-----Cut letters below and glue above from left to right-----

a

e

l

n

p

Name _____



g a s m a s k

-----Cut letters below and glue above from left to right-----

s m a a g k s

Name _____



c

o

f

f

e

e

-----Cut letters below and glue above from left to right-----

e

f

e

o

f

c

Name _____

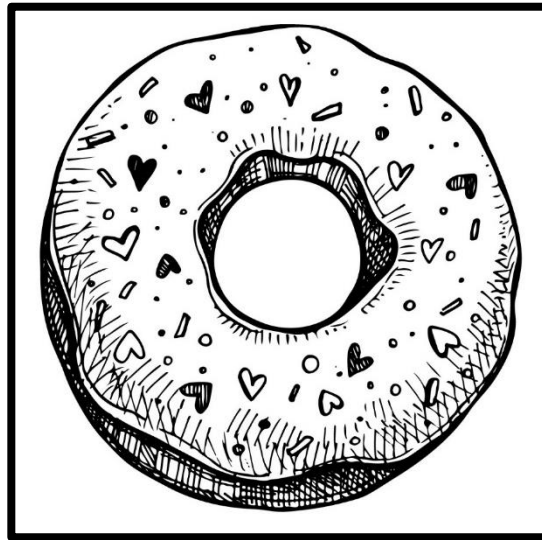

d

o

n

u

t

-----Cut letters below and glue above from left to right-----

 o

n

t

d

u

Name _____

Directions:

1. Cut out the boxes with the words
2. Glue the words under the correct picture

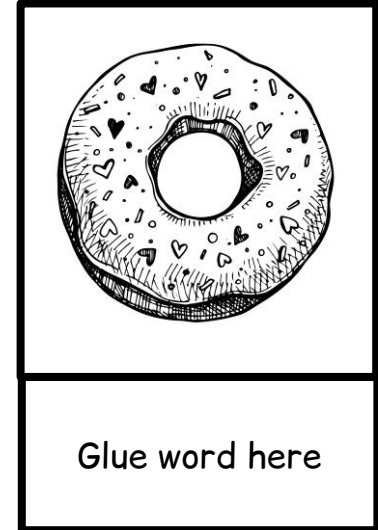
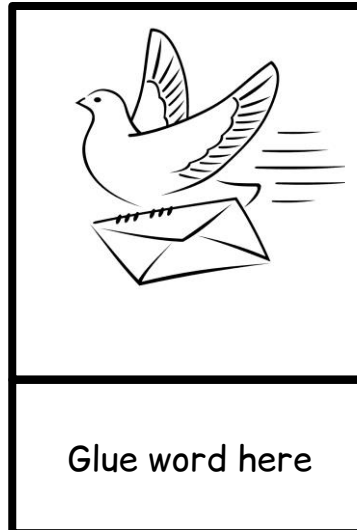
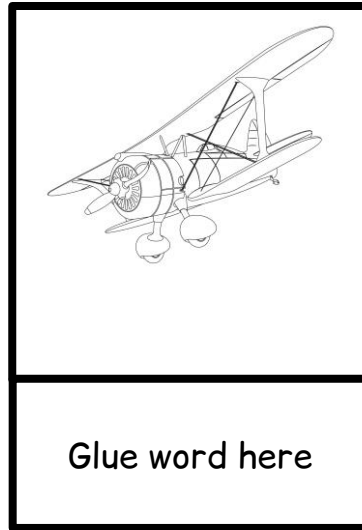
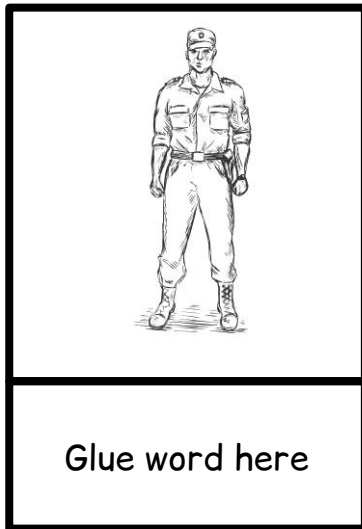

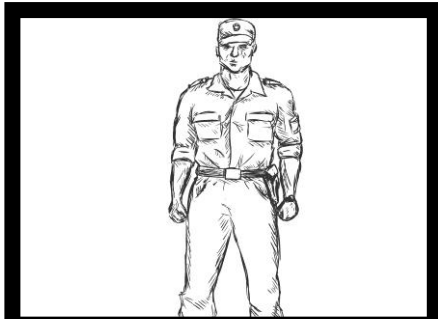

soldier

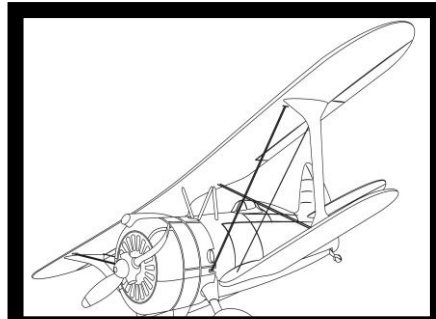

plane

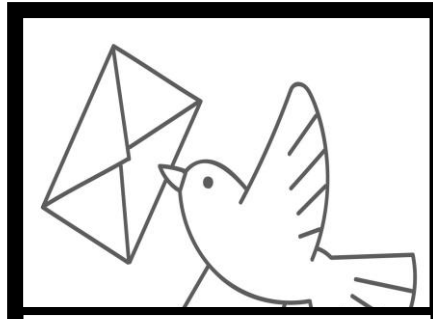

pigeon

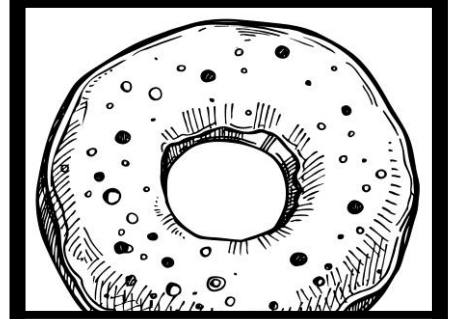

donut

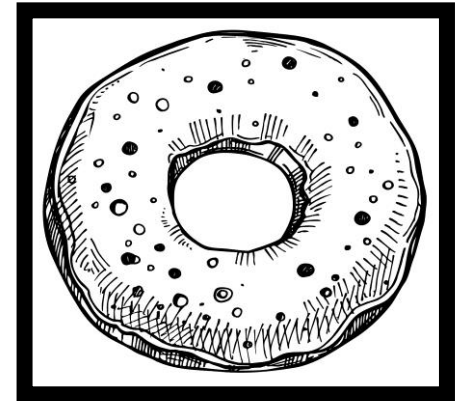
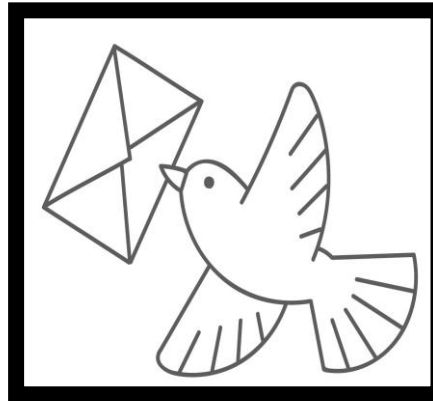
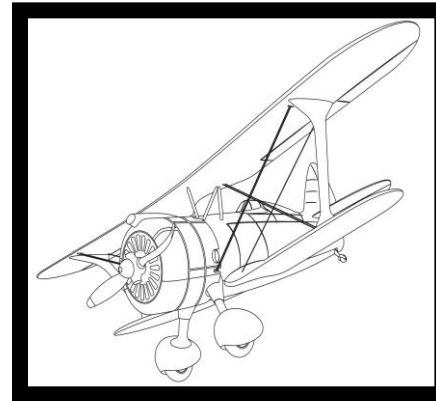
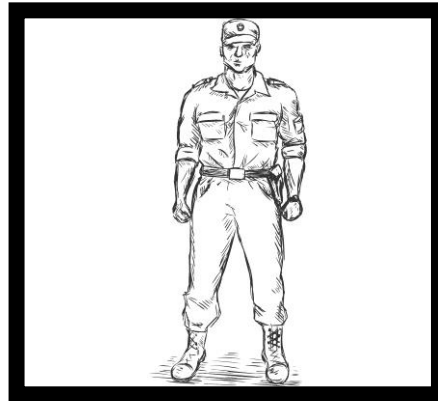

soldier

plane

pigeon

donut

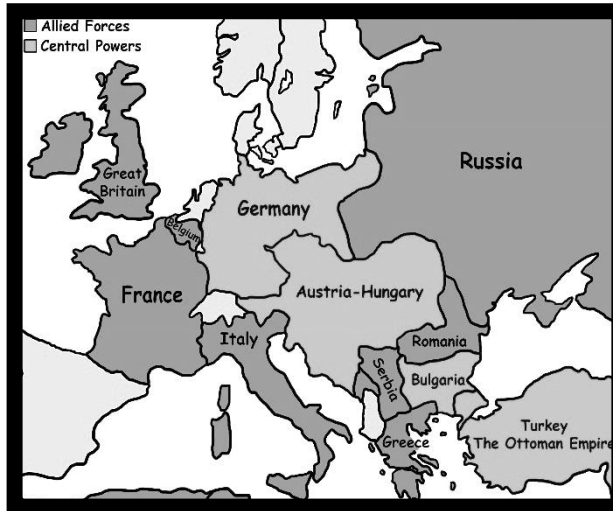

Jo Ann Briseno

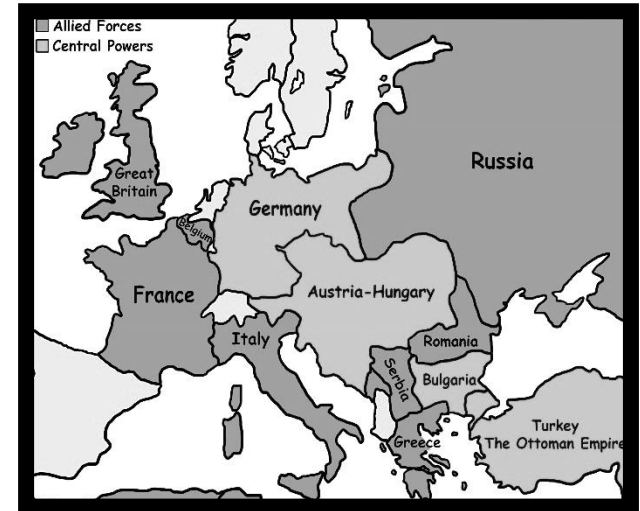

Jo Ann Briseno

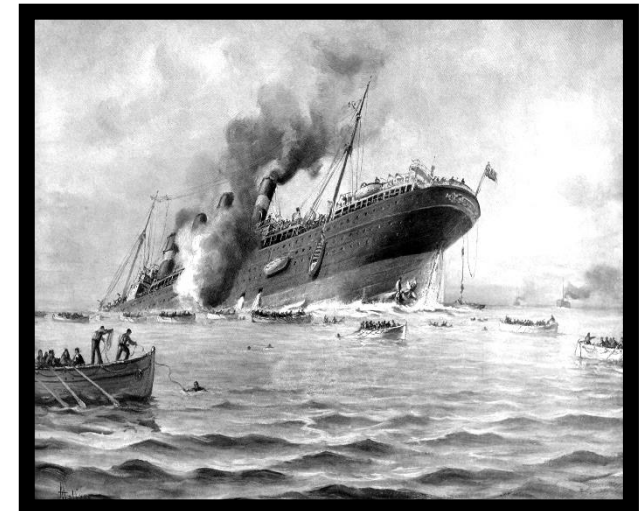

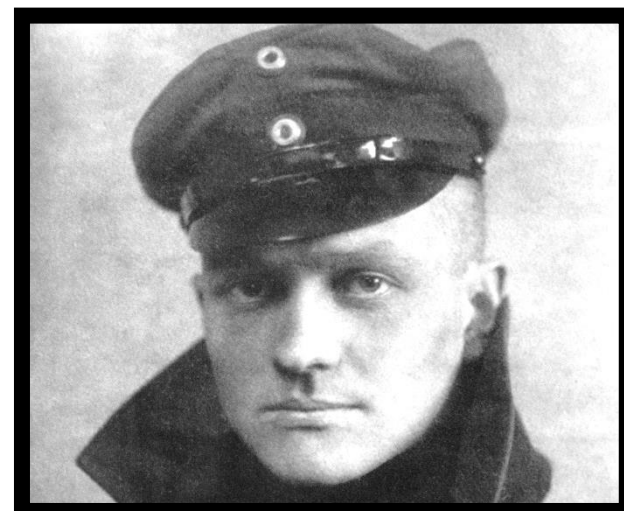

Johnbraid/Shutterstock.com



Adam Jan Figel/Shutterstock, Inc.