



Presents

Wright Brothers

Printable Worksheet Booklet

(Print Portrait)



Name _____

The Wright Brothers were mechanics. Mechanics fix machines.
If you were a mechanic, what would you like to fix?
Directions:
1. Fill in the blank with your opinion.
2. Why did you pick that reason?

cars

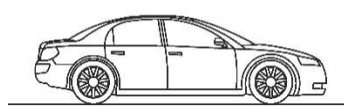

trains

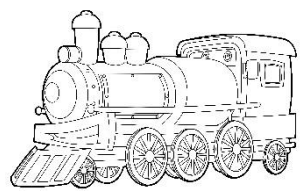

motorcycles



airplanes

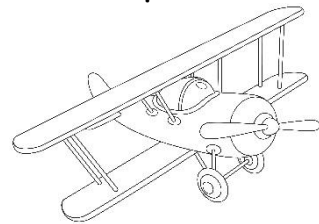

I would like to fix _____ because

Name _____

Fact: The Wright Brothers were good mechanics. A **mechanic** fixes machines. Some mechanics fix cars. Some mechanics fix airplanes. Some mechanics fix trains.

Directions:

1. Would you like to be a mechanic? _____
2. Color the **mechanic**.
3. Write the word "**mechanic**" on the line below.



Name _____

Fact: Old fashion bicycles had a big front wheel. They were difficult to ride. Bicycles have two wheels.

Directions:

1. Can you ride a bicycle? _____
2. Color the **bicycle**.
3. Write the word "bicycle" on the line below.

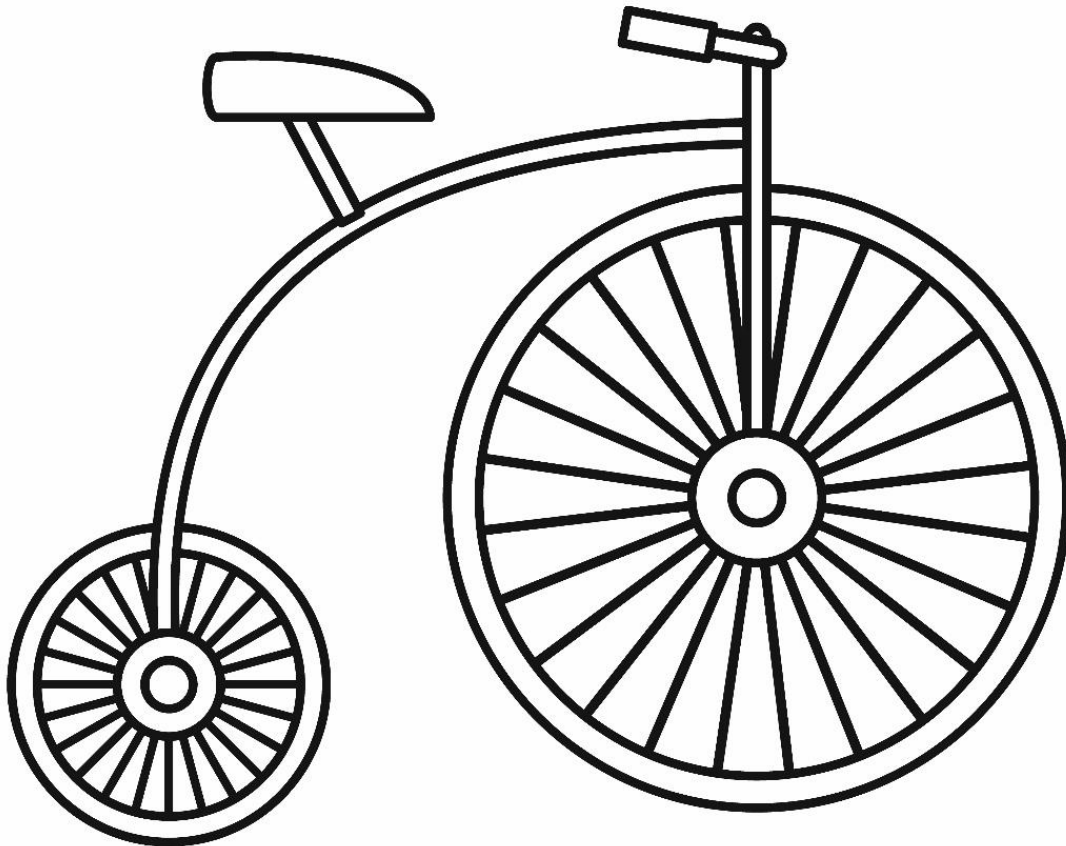

Name _____

Road is what you drive your car or bicycle on.
Rode is the past tense of the verb ride

Directions:

1. Fill in the blank with either the word **road** or **rode**
2. Rewrite the sentence.

1. The _____ was bumpy.

2. My house is on a dirt _____.

3. We _____ our bicycles to school.

4. People _____ bicycles.

5. We _____ on the airplane.

Name _____

Directions: Use the words below to write about the **Wright Brothers and Bicycles.**

Wilbur and Orville Wright	were	bicycles	bicycle shop
brothers	loved	opened	fixed

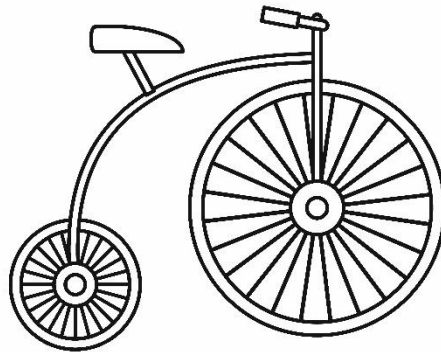

Name _____

Directions: Use the Word Bank to label the parts of the bike.

seat	wheel	handlebars	spokes
------	-------	------------	--------

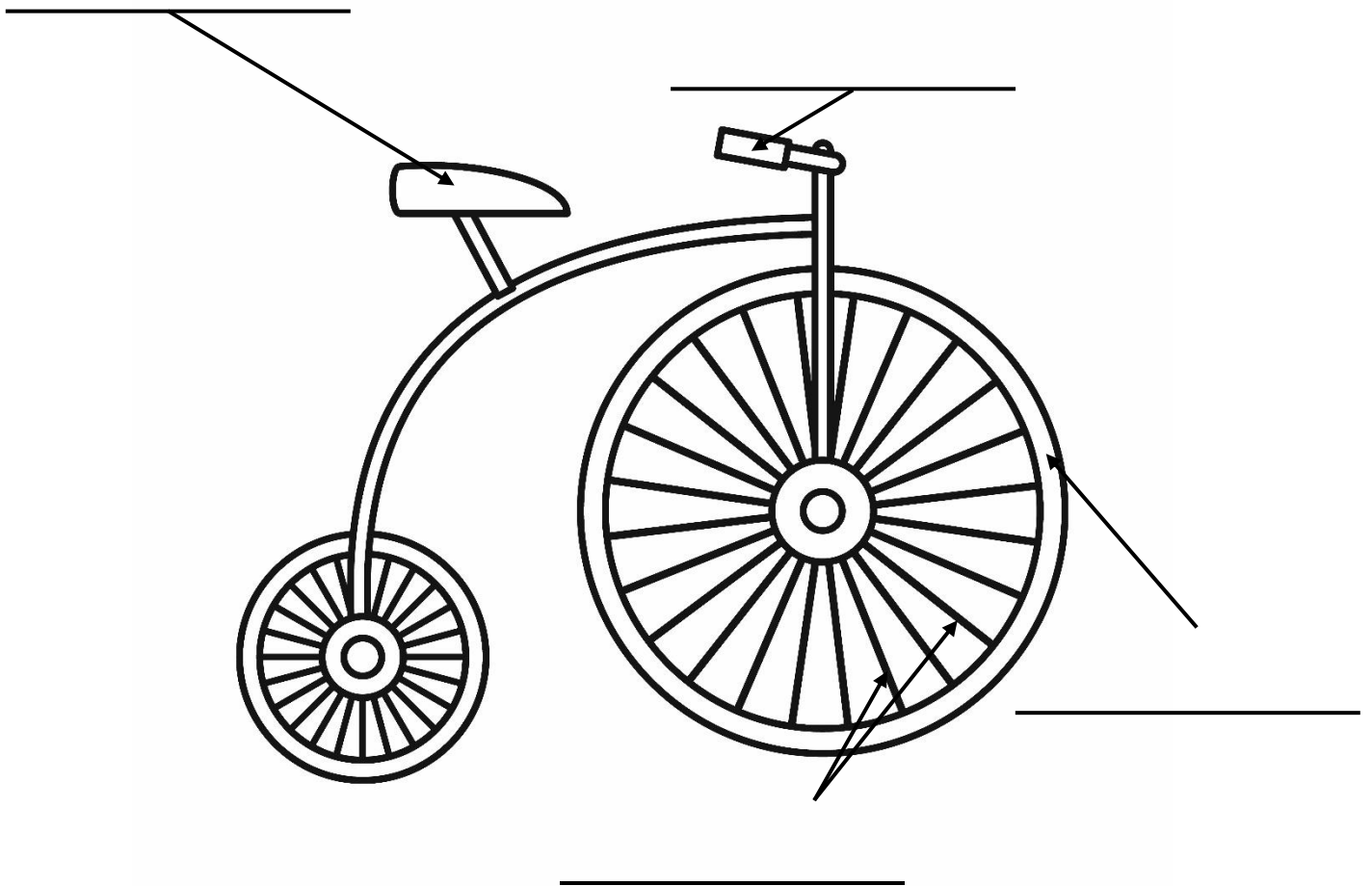

Name _____

Directions: Use the word bank to fill in the blanks.

few - a small number
repair - to fix
invent - to make something new
mechanic - person who fixes machines

1. A person who fixes machines is a _____.

2. Another word for a small number is _____.

3. To fix means _____.

4. To make something new is to _____.

Name _____

Fact: The Wright Brothers invented the airplane. Their first flight was on **December 14, 1903**. December is in the winter.

1. What **month** was the Wright Brothers first flight? _____.
2. How many days are in December? _____
3. What was the **date** of their first flight? _____
4. Find December 14 on the calendar. Write **first flight** in the square.

DECEMBER

SUN

MON

TUE

WED

THU

FRI

SAT

					1	2
3	4	5	6	7	8	9
10	11	12	13	14	15	16
17	18	19	20	21	22	23
24	25	26	27	28	29	30
31						

Name _____

Directions: Use the words below to write about the first flight.

Wilbur and Orville Wright	flew	Kitty Hawk	December 14, 1903
invented	airplane	North Carolina	

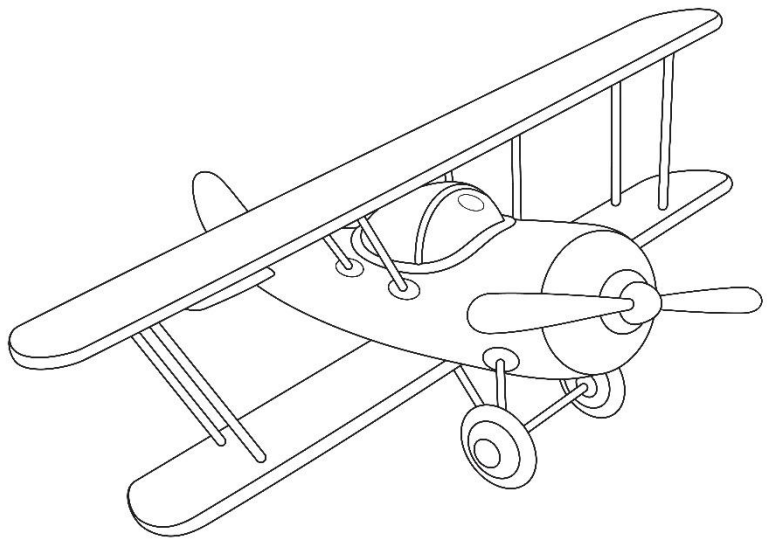

Name _____

Fact: The Wright Brothers opened a bicycle shop in **Ohio**. They flew their first airplane in Kitty Hawk, **North Carolina**.

1. Color **Ohio** red.
2. Color **North Carolina** green.
3. Cut out the bicycle in the box for **Ohio**.
4. Cut out the airplane and paste it in the box for **North Carolina**.

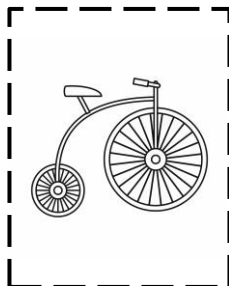
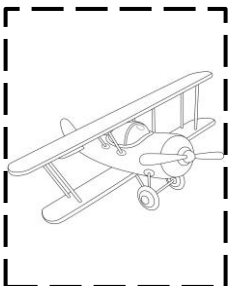
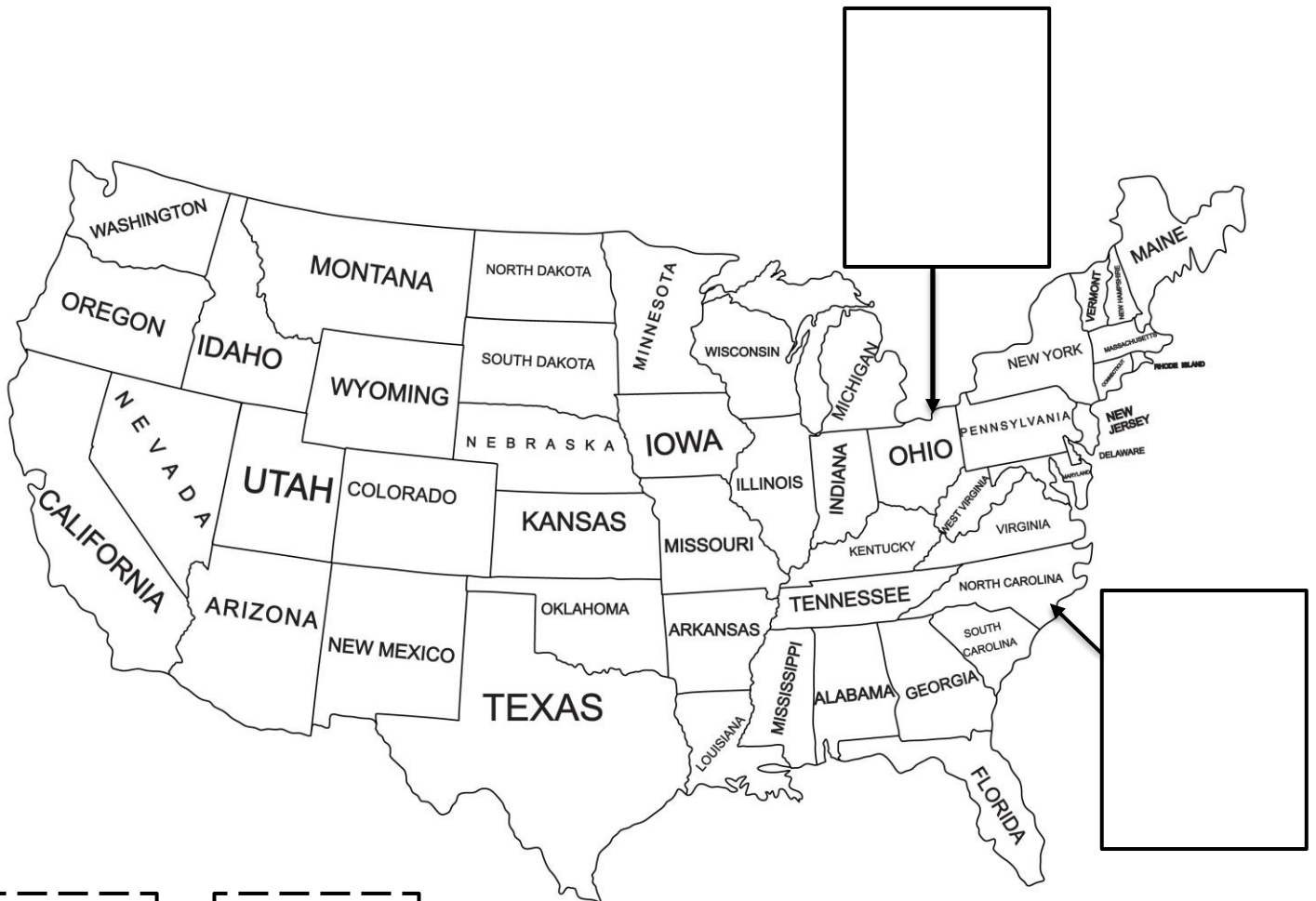

Name _____

Fact: The Wright brothers worked on inventing an **airplane** for a long time. They were excited when they got it to work!

Directions:

1. Have you flown in an airplane? _____
2. Color the **airplane**.
3. Write the word "airplane" on the line below.

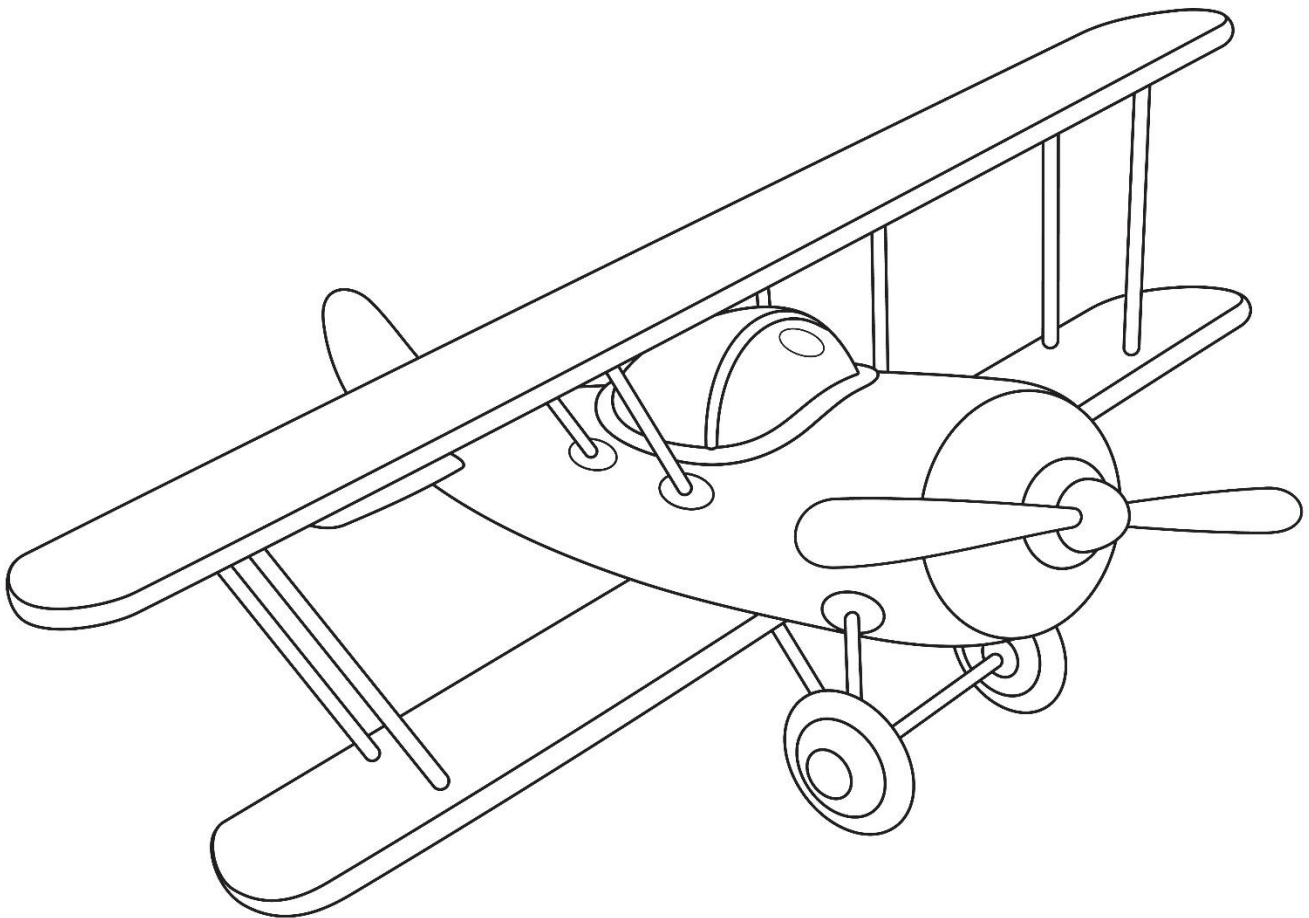

Name _____

Directions:

1. Circle each picture of a **thing that can fly**.
2. Put an "X" on each picture that can not fly.

Supplemental Activity:

1. Cut out each **thing that can fly**.
2. Glue each **thing that can fly** on a sheet of paper.

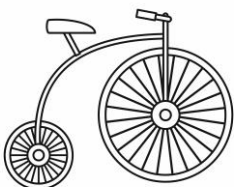
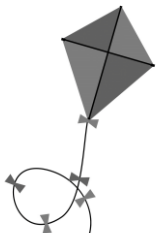
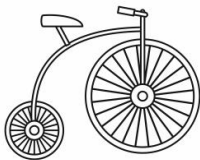
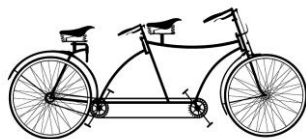
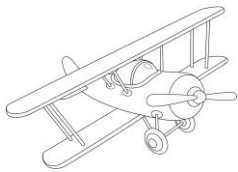

Name _____

Directions: Draw a line from the definition to the matching word.

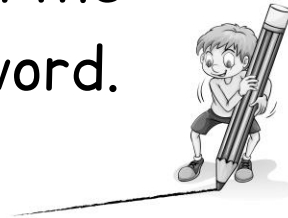

to make something new

mechanic

a person who fixes machines

invent

a small number

repair

to fix

few



Name _____

Directions: Answer the question and fill in the blanks.

The answer to a **What** question gives more information.

Orville and Wilbur Wright were brothers.

What were Orville and Wilbur Wright? _____.

Orville and Wilbur Wright were _____.

The Wright Brothers liked to fix bicycles.

What did Orville and Wilbur like to fix? _____.

Orville and Wilbur liked to fix _____.

The Wright Brothers opened a bicycle shop.

What did the Wright Brothers open? _____.

The Wright Brothers opened a _____.

The Wright Brothers invented an airplane.

What did Orville and Wilbur invent? _____.

Orville and Wilbur invented an _____.

Name _____

Directions:

1. Cut out each box below.
2. Paste each box into the correct space.

bicycles

Wright

airplane

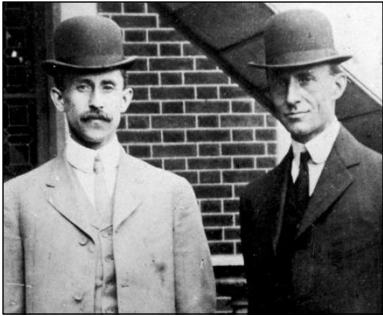

These are the _____
Brothers.

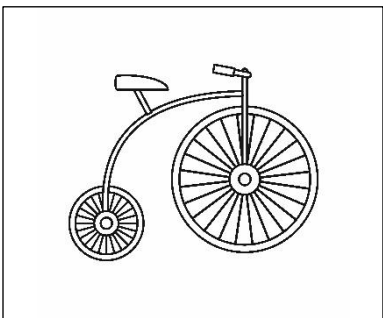

They both loved _____.

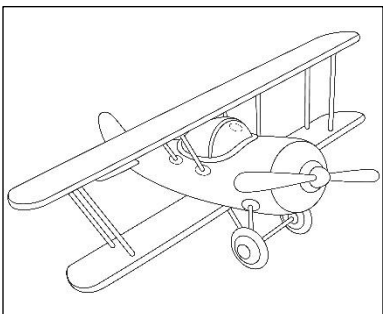

They invented the _____.

Name _____

Directions: Use the words in the **Word Bank** to fill in the blank.

inventing	brothers	bicycle
glider	airplane	

1. Orville and Wilbur Wright were _____ . (Page 1)

2. The Wright Brothers were very good a fixing and _____ things. (Page 2)

3. Wilbur and Orville opened a _____ shop. (page 5)

4. They invented a _____ that a person could ride. (Page 7)

5. They invented an _____ . (page 8)



Directions: Write a letter to the **Wright Brothers National Memorial**. Ask them a question about the Wright Brothers.

Wright Brothers National Memorial
1401 National Park Drive
Manteo, NC 27954

Sincerely,

Name _____

Directions:

1. Cut out the pictures at the bottom of the page.
2. Glue pictures to match the pattern.

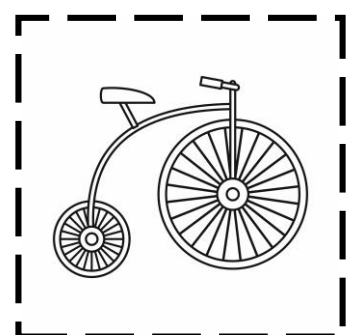
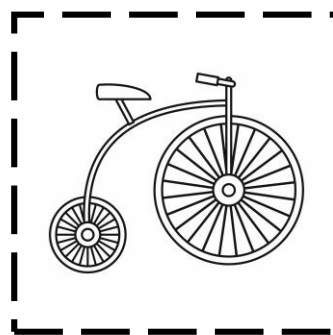
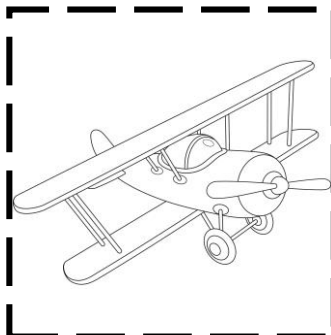
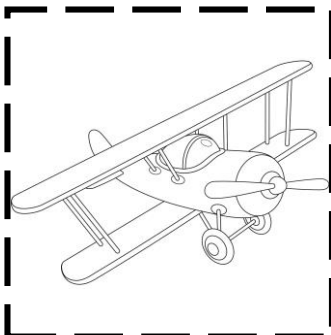
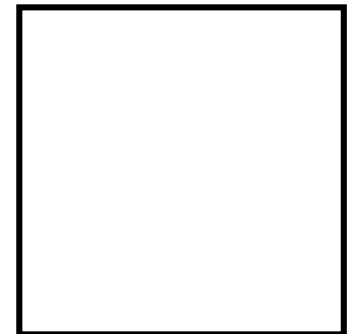
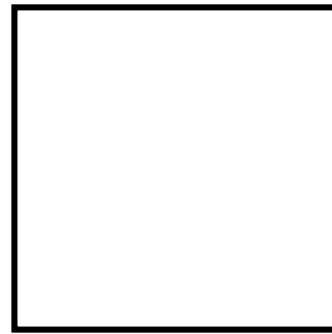
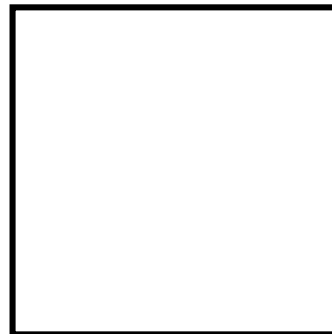
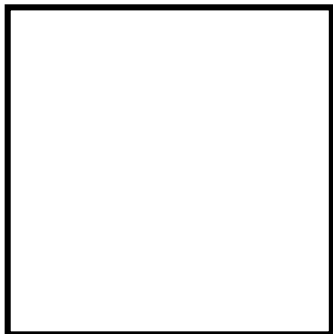
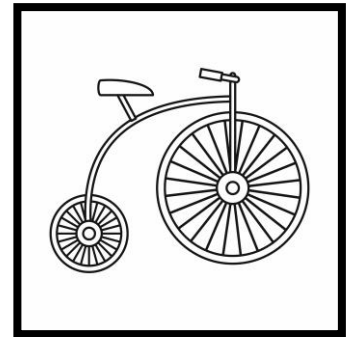
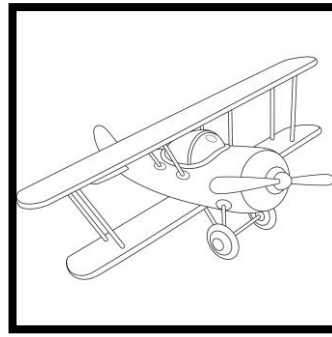
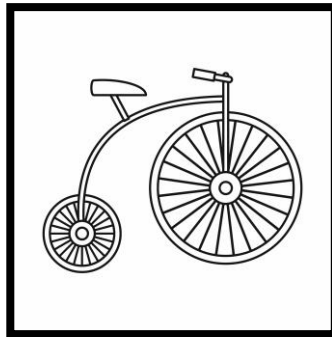
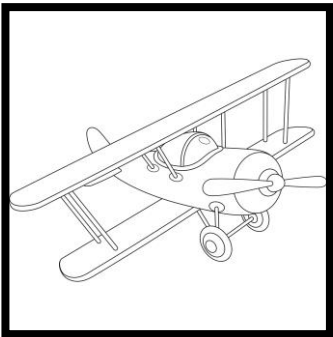

Name _____

Directions: Answer the question and fill in the blank.

The Wright Brothers invented the airplane.

Who invented the airplane? _____

_____ invented the airplane.

The Wright Brothers opened a bicycle shop in Ohio.

Where did the Wright Brothers open a bicycle shop? _____

The Wright Brothers opened a bicycle shop in _____.

They flew their airplane in Kitty Hawk, North Carolina.

Where did they fly their airplane? _____

They flew their airplane in _____.

They flew their airplane on December 14, 1903.

When did they fly their airplane? _____

They flew their airplane on _____.

Name _____

Directions: Draw a line from the word to the matching picture.



bicycle

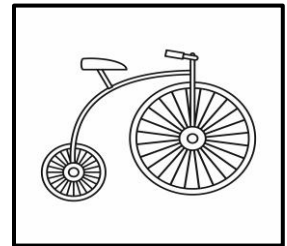

airplane

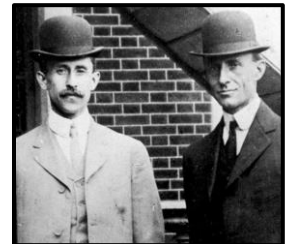

kite

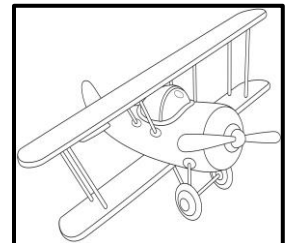

Wright Brothers

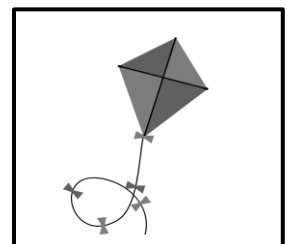

Name _____

Directions: Unscramble the words to make a sentence.
The word(s) in bold is the first word(s) in the sentence.

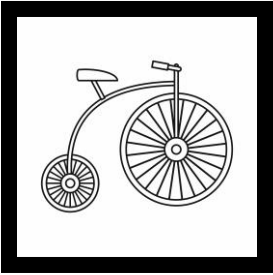

The Wright Brothers bicycles loved

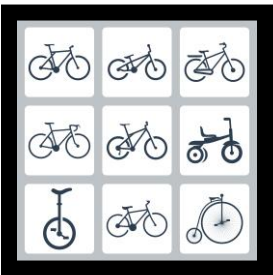

Wilbur and Orville a opened shop bicycle

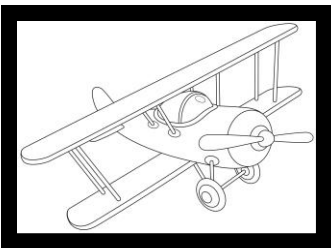

an invented airplane **The Wright Brothers**

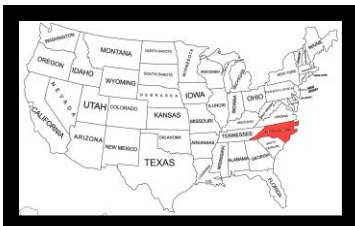

They plane the flew in North Carolina

Name _____

Directions:

1. Fill in the blanks with the words in bold.
2. Rewrite the sentence.

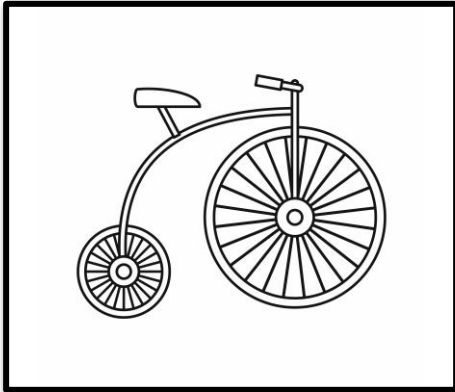

This is a **bicycle**.

This is a _____.



This is a **mechanic**.

This is a _____.

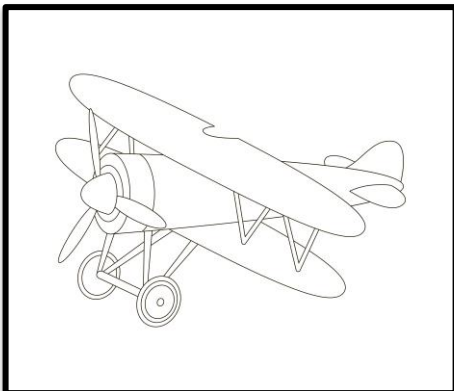

This is an **airplane**.

This is an _____.

Name _____

Directions:

1. Circle each airplane.
2. Put an "X" on each picture that is not.

Supplemental Activity:

1. Cut out each airplane.
2. Glue pictures of each airplane on a sheet of paper.

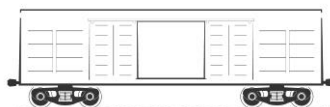
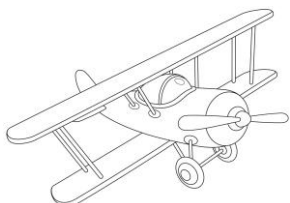
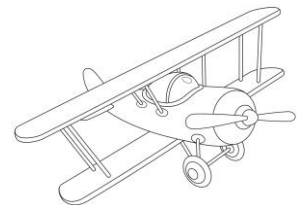
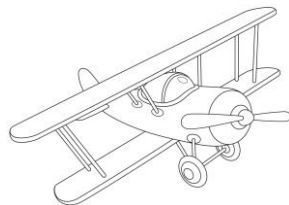
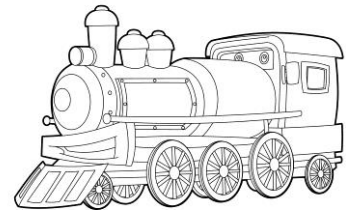
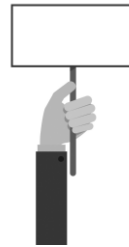
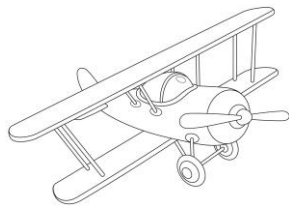
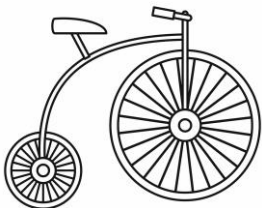
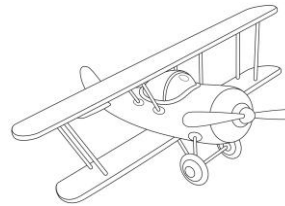
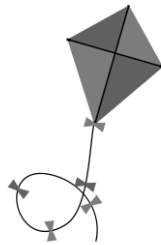
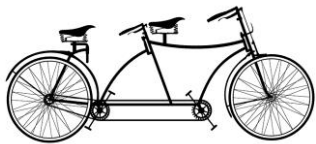
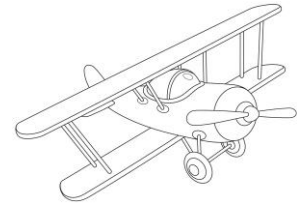



Name _____

Directions: After the first question is answered, use your main idea cards to answer the additional questions.

What do you know about the Wright Brothers? _____

Who invented the first airplane? _____.

What was one thing that the Wright Brothers liked to fix?

_____.

What was different about old bicycles? _____.

What kind of shop did the Wright Brothers open? _____.

What did the Wright Brothers fly in Kitty Hawk, North Carolina?

1. Cut out flashcards
2. Play games matching words with the definition.

repair

to fix

invent

to make
something new

mechanic

person who fixes
machines

few

a small number

Each card represents the main idea for a page in the book. Use these to study content topics with the book. Match each word with a page in book. To engage, play games with the cards. Discuss the word as it relates to the info. on each page.

Orville and
Wilbur Wright

mechanics

big front
wheel

bicycles

bicycle shop

kite

glider

Kitty Hawk,
North Carolina

Industrial
Revolution